



RX2105 model shown

The HOBO MicroRX Station for HOBOnet provides continuous logging for both indoor and outdoor environments with wireless sensor motes and up to five smart sensors. Logged data from the station is transferred at regular connection intervals to HOBOLink® web-based software where you can check the latest conditions, view graphs, configure sensors and alarms, set up a dashboard, download your data, or schedule data delivery via email or FTP. This durable, compact station has a built-in LCD screen to check the current system configuration and status, start and stop logging, add and remove sensors, and connect to HOBOLink on demand. The station offers two primary power source options depending on your deployment needs: the RX2105 model includes user-replaceable AA lithium batteries and an AC adapter while the RX2106 model is designed with a built-in solar panel and rechargeable NiMH battery pack.

HOBO MicroRX Station for HOBOnet

Models:

- RX2105 MicroRX Station
- RX2106 MicroRX Station with Solar Panel
- RX210x-900 (US)
- RX210x-868 (Europe)
- RX210x-921 (Taiwan)
- RX210x-922 (Australia/NZ)

Included Items:

- RX Manager
- Grease packet
- Screws and washers
- Cable ties
- Six AA lithium batteries and AC adapter (P-AC-1) with RX2105
- Rechargeable battery pack with RX2106

Required Items:

- HOBOLink
- HOBOnet RXW motes

Optional Items:

- Smart sensors
- Ground wire (CABLE-MICRO-G)
- 2-meter tripod (M-TPB)
- 3-meter tripod (M-TPA)
- 1.5 meter mast (M-MPB)
- 1-5/8 inch U-bolts (U-BOLT-KIT2)
- Guy wire kit (M-GWA)
- 1/2 inch stake kit (M-SKA)

Sensors and accessories are available at www.onsetcomp.com.

Specifications



Station

Operating Range	RX2105: -40° to 60°C (-40° to 140°F) RX2106: -20° to 60°C (-4° to 140°F)
Smart Sensor Connectors	5
Smart Sensor Network Cable Length	100 m (328 ft) maximum
Smart Sensor Data Channels	Maximum of 15 (some smart sensors use more than one data channel; see sensor manual for details)
Logging Rate	1 minute to 18 hours
Time Accuracy	±8 seconds per month in 0° to 40°C (32°F to 104°F) range; ±30 seconds per month in -40° to 60°C (-40° to 140°F) range
Battery Type/Power Source	RX2105: AC power adapter (P-AC-1) and 6 AA 1.5 V lithium batteries RX2106: Integrated 1.7 watt solar panel and NiMH rechargeable battery pack; optional AC power adapter (P-AC-1) or external solar panel (SOLAR-xW) can be used in place of integrated solar panel
Battery Life/Power Source	RX2105: Runs continuously with the included AC adapter. Batteries can be used as a backup to AC power; battery life of 3 months with 1 minute logging and daily connections or 2 months with 1 minute logging and hourly connections, and with approximately 10 motes. Note: Deployments in areas with weak cellular strength could reduce battery life. RX2106: Typical 3–5 years when operated in the temperature range -20° to 40°C (-4° to 104°F); operation outside this range will reduce the battery service life. Maximum connection rates with built-in solar panel, in full sun: <ul style="list-style-type: none"> • 10 minute connections year round for latitudes less than ±40° • 10 minute connections through three seasons in other regions, reduced to 30 minute connections in winter Maximum connection rates with external 5W or 15W solar panels: <ul style="list-style-type: none"> • 10 minute connections year round, in full sun • Connection rate with external solar panels may be less if deployed in partial sun Battery life of 1 month without solar recharging, with hourly connections, 1 minute logging, and approximately 10 motes.
Alarm Notification Latency	Logging interval plus 2–4 minutes, typical
Enclosure Access	Hinged door secured by two latches with eyelets for use with user-supplied padlocks
LCD	LCD is visible from 0° to 50°C (32° to 122°F); the LCD may react slowly or go blank in temperatures outside this range
Materials	Outer enclosure: Polycarbonate/PBT blend with brass inserts; Interior: Polycarbonate/PBT; Gasket: Silicone foam; Cable channel: Santoprene™ TPE; U-Bolts (not included): Steel with zinc dichromate finish

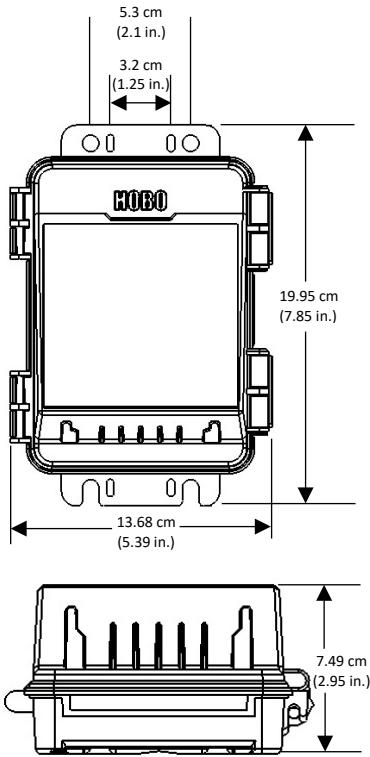
Specifications (continued)



Dimensions

Dimensions	19.95 x 13.68 x 7.49 cm (7.85 x 5.39 x 2.95 in.); see diagrams at left
Weight	678 g (23.9 oz)
Mounting	Optional U-bolts are compatible with masts up to 4.14 cm (1.63 in.) mast diameter; can also be mounted with zip ties or mounted to a flat surface with screws
Environmental Rating	Weatherproof enclosure, NEMA 4X and IP66 (requires proper installation of cable channel system)
Wireless Radio	GSM/GPRS/EDGE: Quad band 850/900/1800/1900 MHz UMTS/HSPA+: Seven band 800/850/900/1800/1900/2100 MHz LTE: Twelve Band 700/800/850/900/1800/1900/2100/2600 MHz
Antenna	4G LTE
	The CE Marking identifies this product as complying with all relevant directives in the European Union (EU)
	See last page, FCC ID QIPPLS62-W, IC ID:7830A-PLS62W
Manager	
Operating Range	-25° to 60°C (-13° to 140°F)
Radio Power	12.6 mW (+11 dBm) non-adjustable
Transmission Range	Reliable connection to 457.2 m (1,500 ft) line of sight at 1.8 m (6 ft) high Reliable connection to 609.6 m (2,000 ft) line of sight at 3 m (10 ft) high
Wireless Data Standard	IEEE 802.15.4
Radio Operating Frequencies	RX210x-900: 904–924 MHz RX210x-868: 866.5 MHz RX210x-921: 921 MHz RX210x-922: 916–924 MHz
Modulation Employed	OQPSK (Offset Quadrature Phase Shift Keying)
Data Rate	Up to 250 kbps, non-adjustable
Duty Cycle	<1%
Maximum Number of Motes	Up to 50 wireless sensors or 336 data channels per one HOBO RX station
Power Source	Powered by the station
Dimensions	Mote: 16.2 x 8.59 x 4.14 cm (6.38 x 3.38 x 1.63 inches) Cable length: 2 m (6.56 ft)
Weight	159 g (5.62 oz)
Materials	PCPBT, silicone rubber seal
Environmental Rating	IP67, NEMA 6

Device Components and Operation

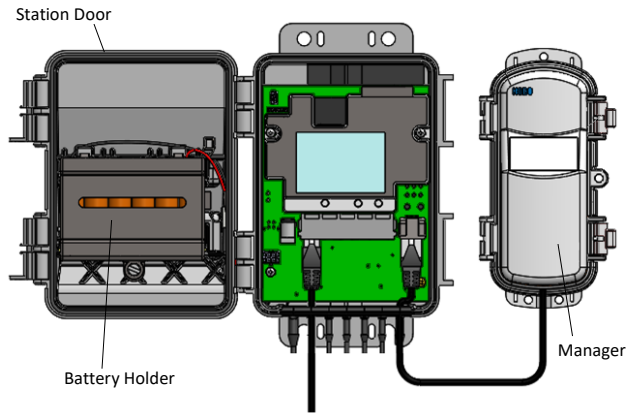

RX2105 model shown

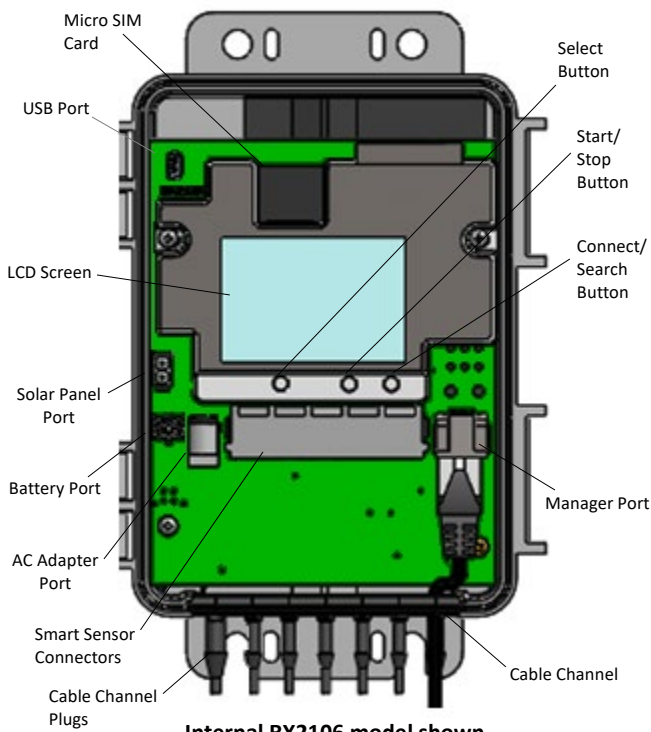

Internal RX2106 model shown

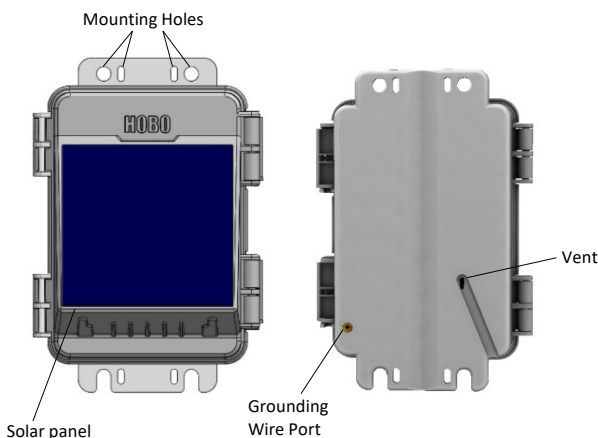

RX2106 model shown

Station Door: This is the protective, hinged door covering the LCD and electronics. The station serial number and device key needed for HOBOLink registration are located on the inside of the door.

Battery Holder: The location where batteries are installed (AA 1.5 V lithium batteries for RX2105 models or a NiMH battery pack for RX2106 models); see both *Battery Information* sections.

Manager: The mote connected to the station that transmits and receives data to and from wireless motes in the network.

Micro SIM Card: This enables cellular communications.

USB Port: Use this port to connect the station to the computer via USB cable as needed for HOBOWare® if you are installing your own micro SIM card or for data offload to CSV file.

LCD Screen: This shows details about system, module, and sensor operation (see *LCD Operation*).

Solar Panel Port: In RX2106 models, use this port to plug in the built-in solar panel or an external solar panel with a higher wattage (see *Setting up the Station*).

Battery Port: Use this port to plug in the internal battery cable (see *Setting up the Station* and both *Battery Information* sections).

AC Adapter Port: Use this port to plug in an AC adapter (see both *Battery Information* sections).

Smart Sensor Connectors: Use these input jacks to connect up to 5 smart sensors (see *Setting up the Station*). The station can support up to 15 smart sensor data channels; some smart sensors have more than one data channel.

Cable Channel Plugs: Use these plugs to fill empty holes in the cable channel (see *Installing the Cable Channel*).

Cable Channel: Use this for routing sensor cables and other wires to protect the interior of the station or to create a weatherproof seal. Any open holes should be sealed with the integrated plugs (see *Installing the Cable Channel*).

Manager Port: This port is used to connect the manager for wireless network communications.

Connect/Search Button: Use this button to connect to HOBOLink or search for new smart or wireless sensors (see *LCD Operation*).

Start/Stop Button: Use this button to start and stop logging or clear a fault code (see *LCD Operation*).

Select Button: Use this button to cycle through information about the smart sensors and manager module (see *LCD Operation*).

Mounting Holes: Use the inner or outer holes at the top and bottom of the logger to mount it (see *Mounting the Station*).

Solar Panel: This is the 1.7 watt solar panel built into the front of the station door in RX2106 models.

Grounding Wire Port: Use this port on the back of the station to connect a grounding wire (CABLE-MICRO-G) (see *Installing the Grounding Wire*).

Vent: This vent allows pressure to equalize inside the station while keeping water out.

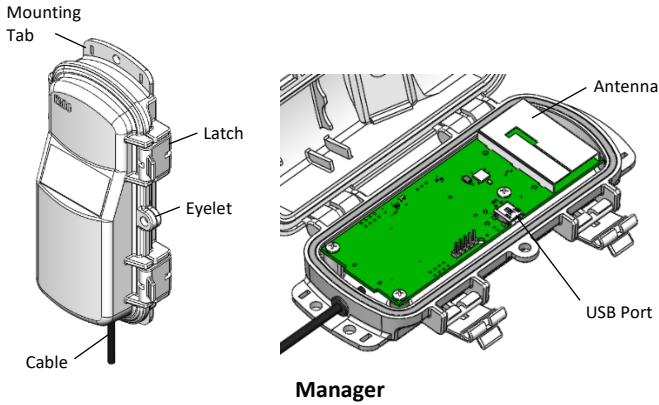

Mounting Tab: Use the tabs at the top and bottom of the mote to mount it (see *Deployment Guidelines*).

Cable: Use this cable to connect the manager to the station.

Eyelet: Use this eyelet to attach a 3/16 inch padlock to the mote for security.

Latch: Use the two latches to open and close the mote door.

Antenna: This is the built-in antenna for the radio communications across the wireless network.

USB Port: Use this port to connect to the mote to a computer via USB cable if you need to update the firmware (see *Updating Manager Firmware*).

LCD Operation

This example shows all symbols illuminated on the LCD screen with an overview of what each section of the LCD represents. Refer to the table below for details about each section and associated symbols.

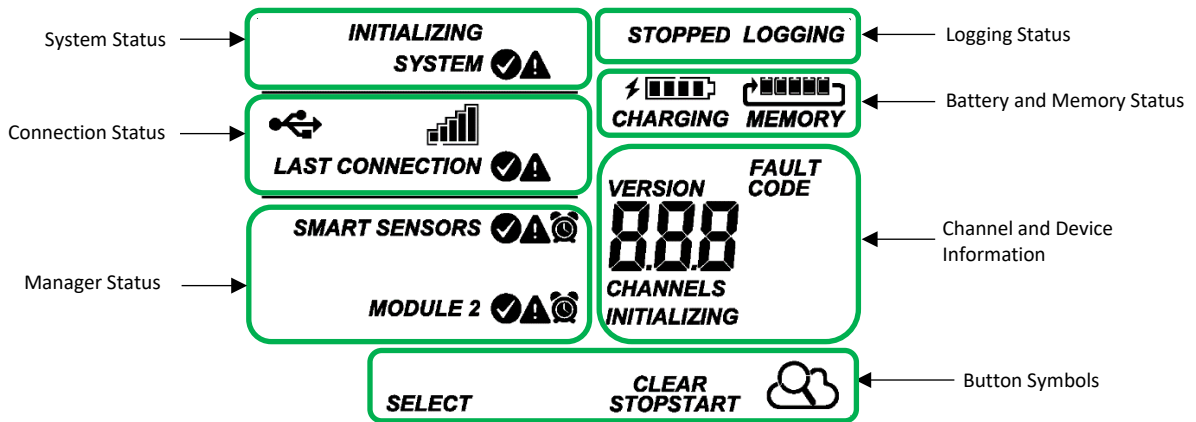

<p>System Status</p> <p>SYSTEM or INITIALIZING SYSTEM</p>	<p>This part of the LCD shows the overall system status.</p> <p>When the station is powered up, “Initializing System” flashes in the upper left part of the LCD. After initialization is complete, “System” remains illuminated and one of these symbols will appear:</p> <ul style="list-style-type: none"> ✔ indicates the system is ok. ⚠ indicates there is a problem with the system; check the Device Information panel on your station page in HOBOLink.
<p>Connection Status</p> <p>🔌</p> <p>📶</p> <p>CONNECTION or LAST CONNECTION</p>	<p>This part of the LCD shows the status of the HOBOLink connection and other items.</p> <p>This indicates the station is connected to a USB cable.</p> <p>This shows the strength of the cellular signal; the more bars there are, the stronger the signal. This will blink while connecting to HOBOLink.</p> <p>When the station is attempting to connect or is currently connected to HOBOLink, “Connection” flashes on the LCD. After the connection is complete, “Last Connection” remains illuminated and one of these symbols will appear:</p> <ul style="list-style-type: none"> ✔ indicates the last connection to HOBOLink was ok. ⚠ indicates there was a problem with the last connection; check the Connections log in HOBOLink.
<p>Smart Sensor and Module Status</p> <p>SMART SENSORS MODULE 2</p>	<p>This part of the LCD shows the status of the smart sensors and the manager. One of the following symbols will also appear next to smart sensors or module 2 for the manager:</p> <ul style="list-style-type: none"> ✔ indicates the smart sensor or manager module is ok. ⚠ indicates there is a problem with the smart sensor or manager module; check your device page in HOBOLink. 🔔 indicates a sensor alarm has tripped and will flash on the LCD until the alarm is cleared; check the Alarms log in HOBOLink.
<p>Logging Status</p> <p>STOPPED or LOGGING</p>	<p>This part of the LCD indicates whether the station is currently logging.</p> <p>“Stopped” indicates the station is not currently logging while “Logging” indicates it is currently logging. Press the Start/Stop button to start or stop logging as desired. Note that “Logging” will blink until the first data point is logged after the Start button is pressed. Pressing Start will also initiate a connection to HOBOLink. Pressing Stop will stop logging, but it will not initiate a connection to HOBOLink.</p>

Battery and Memory Status

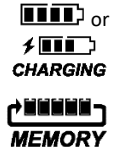

This part of the LCD shows the current battery level and memory.

The battery indicator shows the approximate battery power remaining. In this example, the battery is fully charged. The lightning bolt will appear when an AC adapter or solar panel is plugged into the station. "Charging" will flash while the battery is being charged.

When the station is logging, it will record data indefinitely, with newest data overwriting the oldest data until the station is stopped. This continuous logging is represented by the arrow in this symbol. With normal communication, the memory used will be small, and this icon will show one bar. If the station is not able to connect to HOBOLink, this icon will show the amount of memory that is filled with data waiting to be read out at the next connection.

Channel and Device Information

This part of the LCD shows the number of channels and other information about each module. It also shows general device information. Press the Select button to scroll through the main screen, smart sensors screen, and module 2 for the manager.

Main Screen

When viewing the main LCD screen, the total number of all channels in use by the system is displayed. This is a combination of smart sensor channels and wireless network channels. For example, if there are 5 smart sensor channels and 4 wireless network channels, then 9 channels are shown on the main screen as shown.

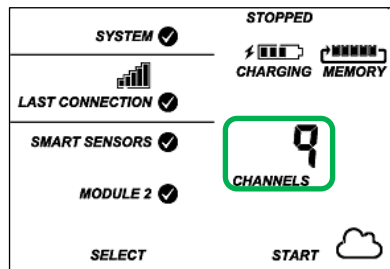

Smart Sensors Screen

When viewing the smart sensors screen, the number of smart sensor channels is displayed. Note that some smart sensors have more than one channel associated with them so the number of channels may not match the number of physical smart sensors. In this example, there are 5 smart sensor channels.

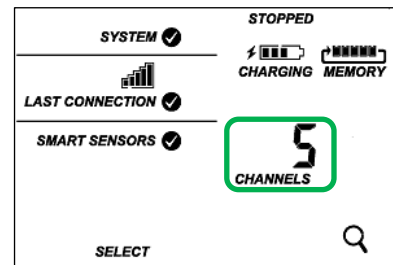

Module 2

When viewing the module 2 screen, information about the manager is displayed. The channel count represents all measurement channels plus a battery channel for each mote in the wireless network. For example, one temperature/RH wireless sensor and one repeater has a channel count of four as shown at right.

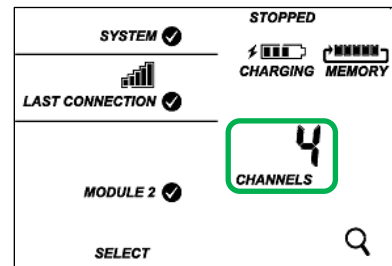

INITIALIZING

This will blink in the lower right part of the LCD when a firmware update is underway. It will display which module or element is being updated.



This is a numerical code that appears when a system fault has occurred. You may need to provide this code to Onset Technical Support. See *Troubleshooting* for details.

This is the version number of the station firmware. It only appears when powering up the device.

Button Symbols

Use the three buttons below the following symbols to operate the station. Press any of the three buttons to turn on the LCD.

SELECT
START
STOP

Press this button to cycle through status information about the smart sensors and module 2.

Press this button to start logging. This option is not available while the station is actively connected to HOBOLink.

Press this button to stop logging. This option is not available while the station is actively connected to HOBOLink.



Press this button to connect to HOBOLink. This option is only available on the main LCD screen. It is not available when scrolling through smart sensor and module information with the Select button. In addition, this option is not available while a connection is underway or active.



Press this Search button for the station to detect all currently installed smart sensors or add motes to your wireless network. As you add or remove smart sensors while the station is stopped, press the Select button and then the Search button for the system to recognize your changes. This option is not available for smart sensors while the station is logging. To add motes to the wireless network, press the Select button to switch to module 2 and then press the Search button for the station to find the motes. The station can search for motes whether it is logging or stopped.

CLEAR

Use this button to clear a fault code.

Notes on LCD Operation:

- The LCD will turn off after 5 minutes of inactivity. Press any button to turn the LCD back on.
- There can be a delay before the LCD updates. For example, if you plug in an AC adapter, it may take a few seconds before the lightning bolt icon appears on the LCD. This delay is by design to preserve battery life.

Setting up the Station

Follow these steps to set up the station.

1. Log into HOBOLink.

Go to www.hobolink.com and log into an existing account or create a new one. You'll receive an email to activate the new account.

2. Register the station.

In HOBOLink, click Devices, then RX Devices, and click the Register a Device link. Give the station a name and enter the serial number and device key from the label inside the station door.

Note: If you are using your own micro SIM card, follow the instructions at <https://www.onsetcomp.com/support/manuals/23845-installing-micro-sim-rx2100-station> before continuing.

3. Plug in smart sensors if applicable.

Plug the smart sensors into the ports below the LCD. When using multiple smart sensors, it is easiest to start by plugging one into the leftmost or rightmost connector and then working your way across the connectors in order. Route the cables through the holes in the cable channel. See *Installing the Cable Channel* for more details.

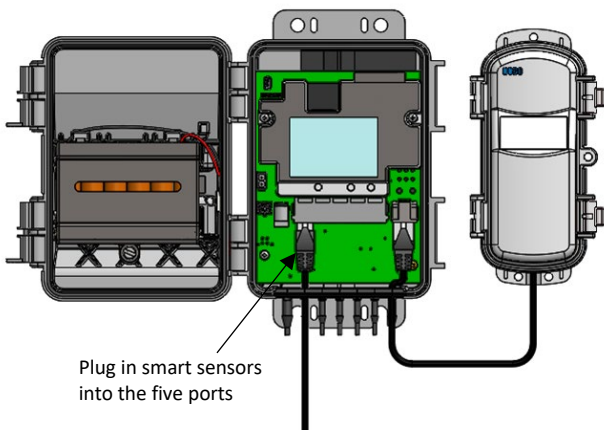

4. Plug in the battery and wait for the station to connect to HOBOLink.

- Plug in the battery cable. For RX2106 models, plug in the solar panel cable for the built-in solar panel. If you are using an external solar panel, tuck the built-in solar panel cable inside the station door.

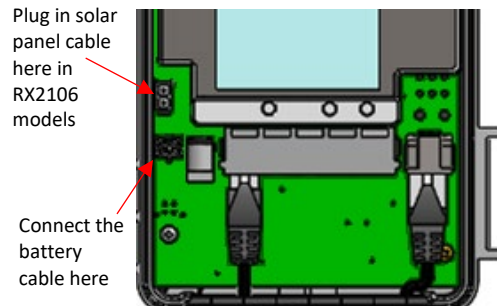

- Once the battery cable is plugged in, "Initializing System" will flash on the LCD. A checkmark appears next to "System" after the station initialization is complete.

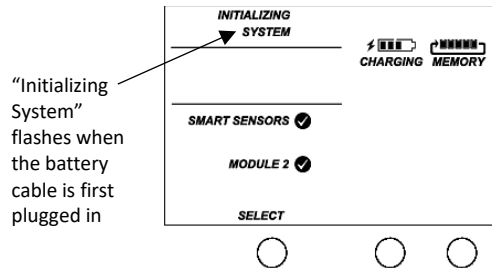

"Initializing System" flashes when the battery cable is first plugged in

- After the station powers up, it will connect to HOBOLink automatically within two minutes. The cellular icon and "Connection" will flash while the connection is underway. Once the connection is complete, a checkmark appears next to Last Connection. Note that the entire initialization process may take several minutes; wait until Last Connection and the checkmark appears before continuing to step 5.

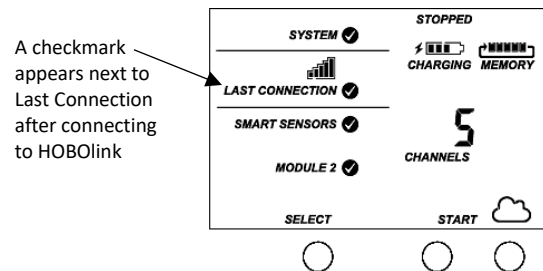

A checkmark appears next to Last Connection after connecting to HOBOLink

5. Add any wireless sensor motes.

Important: Keep the mote(s) near the station while completing these steps.

- Press select to switch to module 2 and then press the Search button to wait for motes to join the network. The magnifying glass icon will blink while the station is in search mode waiting for motes to join the network.

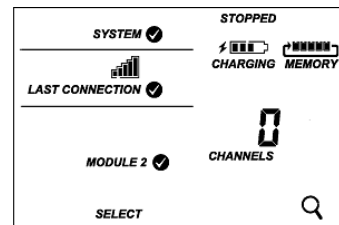

Press the Select button to switch to module 2

Press the Search button for the station to search for motes to join

- b. Install the batteries in the mote and press the button on the mote for 3 seconds.

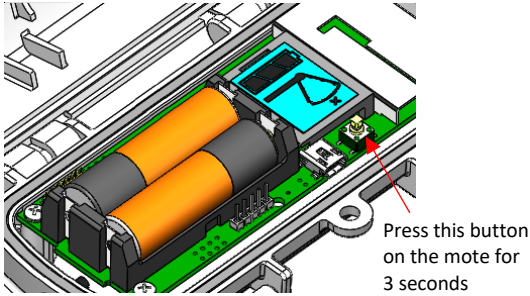

- c. Watch the mote LCD during the process of joining the network.

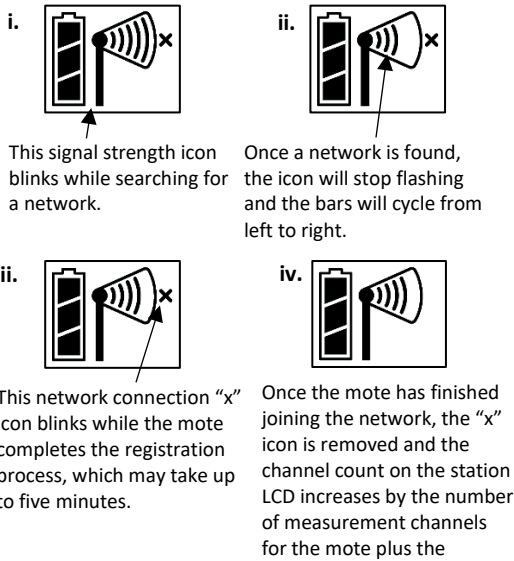

Note: If the mote cannot find the network or has trouble remaining connected during this process, make sure the mote is in a vertical, upright position and within range of the station.

- d. Repeat these steps to add other motes. Press the Search button on the station when finished adding motes.

6. Configure the station in HOBOLink.

In HOBOLink, click Devices, then RX Devices and click the icon next to your station. Use the configuration screens in HOBOLink to finish setting up the station, starting with General Configuration (the nickname, time zone, and image for the station). Use the Next button to move from one configuration screen to the next or use the left menu to select a specific item to configure. Follow the steps in the next subsections to configure the readout settings, smart sensors (if applicable), and wireless sensors. **Note:** Click Save or Next in any screen to save your changes. You will lose any changes made if you click Back without clicking Next or Save first.

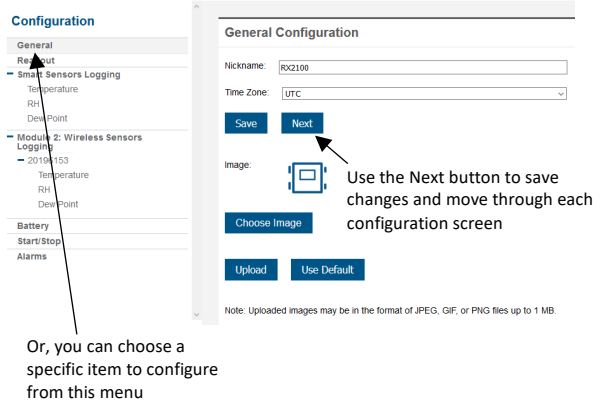

Readout Configuration

- a. Click Readout from the Configuration menu.
- b. Set the connection interval, which is how often the station will connect to HOBOLink. The minimum connection interval depends on your communication plan.
- c. If you wish to set up a second connection interval, select the "Night mode" checkbox. Select when night mode should begin and end and then enter the connection interval you want to use during that part of the day. (The night mode schedule can take effect any time during the day; it does not have to be at night.) Use this option to save data in your communications plan (if applicable) or to conserve battery power at night when solar charging is unavailable. You can view current plan usage in the Device Information section on your station's page in HOBOLink.
- d. Click Save or click Next.

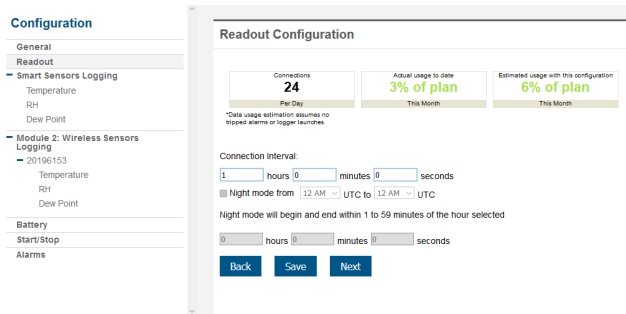

Smart Sensors Logging and Configuration

You can configure both the global settings that affect all smart sensors (logging interval and sampling interval) and the settings for each smart sensor (labels, graphs, and scaling).

- a. Click Smart Sensors Logging from the Configuration menu.
- b. Select the logging interval. This will be used by all configured smart sensors.
- c. Enable the sampling interval and enter the rate to use in minutes and seconds.

Tip: When a sampling interval is configured, the station will take multiple measurements within a given logging interval and then average them together to create a single logged data point. This is only an option for the following smart sensors that support measurement averaging: temperature (S-TMB-M0xx), PAR (S-LIA-M003), solar radiation (S-LIB-M003), barometric pressure (S-BPA-CM10 and S-BPB-CM50), 4-20mA input (S-CIA-CM14), 12-bit voltage input (S-VIA-CM14), and FlexSmart TRMS module (S-FS-TRMSA-D). Disable the sampling interval if none of your smart sensors support measurement averaging to avoid unnecessary drain on the battery power.

d. Click Save or click Next.

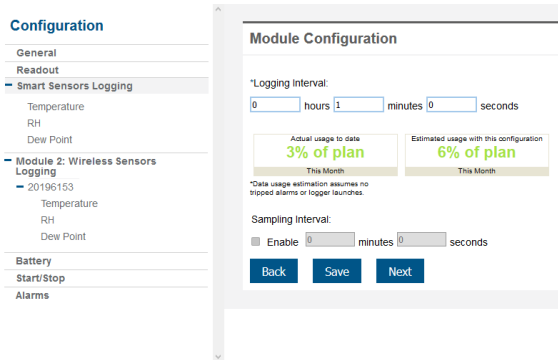

- e. Click a smart sensor from the Configuration menu.
- f. Type a label for the smart sensor (optional) and click to enable or disable the graph (enabled by default).
- g. To set up scaling for the smart sensor, click the Enable Scaling checkbox and fill in the Scaled Units, Multiplier, Offset, and Scaled Measurement Type fields.
- h. Click Save. You can also click Next to move from one smart sensor to the next and save the sensor configuration. Clicking Back does not save the configuration changes.

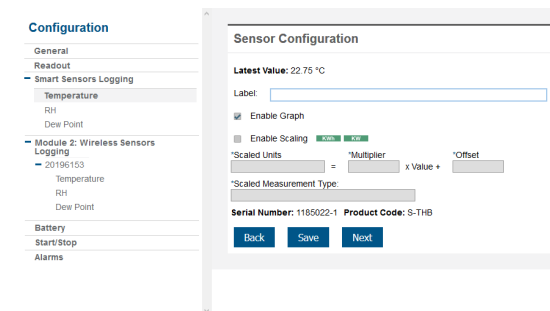

i. Repeat steps e–h for any additional smart sensors you need to configure.

Wireless Sensor Configuration

You can configure both the global settings for the manager module that affect all sensor motes (logging interval) and the settings for each individual mote (labels, enabled graphs, and scaling).

a. Click Module 2: Wireless Sensors Logging from the menu on the left.

b. Select the logging interval to be used for all wireless sensors, which can be different than the one used for smart sensors (if applicable).

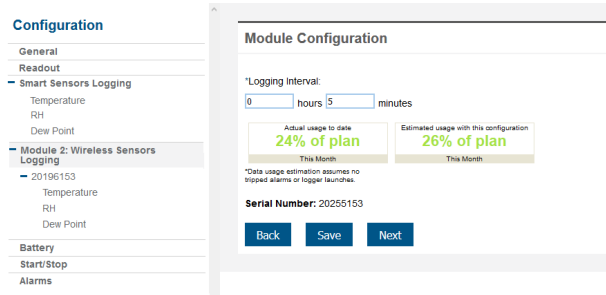

c. Click Save or Next.

d. Click one of the motes from the menu under Module 2: Wireless Sensors Logging as shown in the following example. Click the serial number or name for the mote, not the measurement type.

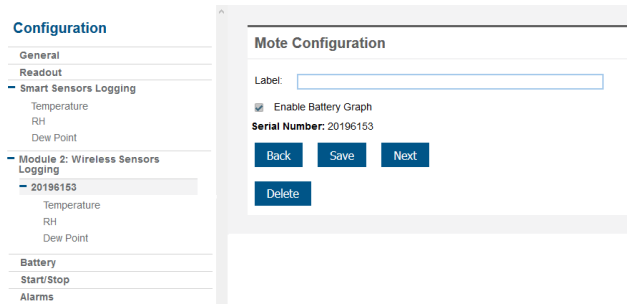

- e. Type a label for the mote (optional) and click to enable the battery graph for the mote if desired. The label will also automatically be applied to any mote sensors without a default label.
- f. Click Save or click to Next to move to either the next mote (if it is a repeater) or the sensor measurement type for that mote.
- g. Click one of the mote measurement types from menu under Module 2: Wireless Sensors Logging as shown in the following example

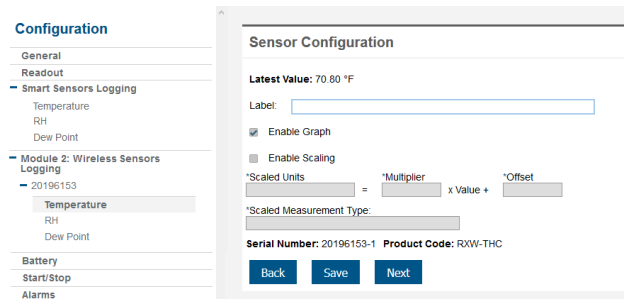

- h. Type a label for the measurement type (optional) and click to enable or disable the graph (enabled by default).
- i. To set up scaling for the wireless sensor, click the Enable Scaling checkbox and fill in the Scaled Units, Multiplier, Offset, and Scaled Measurement Type.
- j. Click Save or click Next.
- k. Repeat steps d–j for any additional motes you need to configure for the module.

7. Start logging.

Press the Start button on the station to start logging. The station will connect to HOBOLink (“Connection” will blink on the LCD) and then logging will begin at the logging interval specified for smart sensors (if applicable) and wireless sensors.

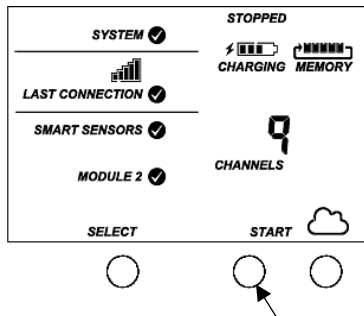

Press this button to start logging

You can also start logging from HOBOLink. Select Start/Stop from the Configure menu in HOBOLink and click Start. Logging will not begin until the next time the station connects to HOBOLink. Press the Connect button on the station to connect to HOBOLink at any time.

Once logging begins, “Logging” appears in the upper right corner of the LCD as shown in the following example. “Logging” will blink until the first logging sample is recorded. At that point, it will stop blinking and remain illuminated until logging is stopped.

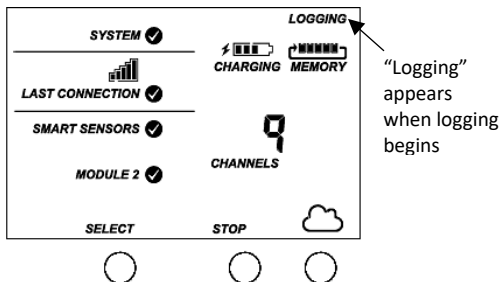

“Logging” appears when logging begins

Measurements are uploaded to HOBOLink each time the station connects.

Important: See *Deploying and Mounting the Station* for installation steps and other deployment guidelines. If using the station outdoors or in harsh indoor conditions, you must install the sensor cable channel. See *Installing the Cable Channel* for details.

Important: If you are using smart sensors only and no wireless sensors, power down the station and unplug the manager to preserve battery power.

Viewing Data in HOBOLink

Data is uploaded to HOBOLink each time the device connects. For a snapshot of the latest conditions, click Devices, then RX Devices, and click the device name to view the readings from

the last connection. You can also view any enabled graphs as shown in the following example.

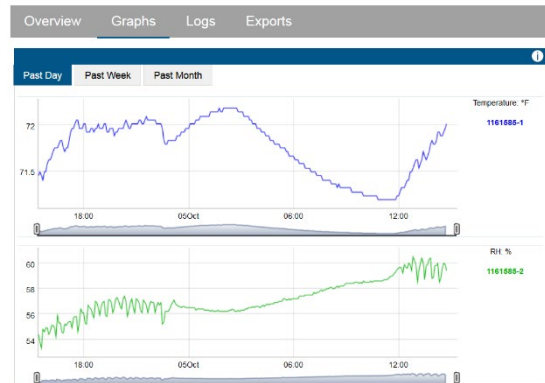

Logged data is saved in a database. You can export this data on demand as needed or set up automatic exports that are delivered to email and/or FTP addresses on a schedule you specify.

To download and export data:

1. In HOBOLink, click Data and then Exports.
2. Click Create New Export.
3. Follow the instructions on the screen to select the name, format, time zone, and time frame, and then the devices and sensors to include in the export. Reorder the sensors as needed.
4. Click Save to keep these settings for future use or click Export Data to export immediately.

To set up a scheduled data delivery:

1. Click Data and then click Data Delivery.
2. Click Create New Delivery.
3. Under General Settings, type the name of the delivery schedule and the frequency of delivery. Enable the Active checkbox. Select other settings if desired.
4. Under Select Data to Export, choose the name of the custom data export you want to be delivered (or follow the previous set of steps to set up a new data export).
5. Under Data Destination, select FTP/SFTP or Email for the delivery method and fill in the appropriate fields.
6. Click Save. Data will then be delivered on the schedule you selected.

See the HOBOLink Help for more information on Data Delivery and other ways to monitor your station, such as using dashboards.

Setting System and Sensor Alarms

You can set up both system and sensor alarms in HOBOLink. System alarms can trip for a missed connection, low battery, smart sensor failure, or missing mote. With a sensor alarm, you can configure an alarm to trip at one measurement level and clear at another. In addition, if you are using a rain gauge with the station, then you can set up an accumulated rain sensor alarm.

System Alarms

To add a system alarm:

1. In HOBOLink, click Devices and then RX Devices, and find the station you want to configure. Click the arrow next to  and select Alarm Configuration.
2. Click Edit System Alarms.
3. For Missed Connection alarms:
 - a. Under Communication, select the Missed Connection checkbox.
 - b. Set the length of time for HOBOLink to wait after the station has missed a connection before an alarm trips.
 - c. Select the action to be taken when this alarm trips: send an email or text. Enter the details and then select "Send on Clear Also" if you want an email or text when the alarm clears as well.

Important: Standard data fees and text messaging rates may apply when using text notifications. Onset does not charge a fee or guarantee delivery of text alerts, which is subject to your carrier's service and location. See the HOBOLink Help for additional details on alarm notifications.

- d. Click Add Action if you want multiple actions to be taken when the alarm trips (for example send an email and a text).
4. For Battery Low and Sensor Failure alarms:
 - a. Under Device, select the Battery Low and/or Sensor Failure checkboxes.
 - b. Select how you want to be notified when these alarms trip: by email or text. Enter the appropriate addresses and then select "Send on Clear Also" if you want an email or text when these alarms clear as well.
5. Click Add Action if you want multiple actions to be taken when the alarm trips (for example send an email and a text).
6. Click Save. Changes will take effect the next time the station connects to HOBOLink.

Red alarm symbols will appear in HOBOLink when these alarms trip (if enabled).

Note for wireless sensors: If a wireless sensor mote goes offline from the network for 30 minutes, the station will automatically connect to HOBOLink to report the missing mote regardless of any alarm settings in place. Unless the mote has no battery power, it will continue logging data even if it is offline from the network. Once the mote is back online, any logged data will be uploaded during regular connections to HOBOLink. **Note:** Once a mote is back online, it enters recovery mode as HOBOLink receives the data logged while it was offline. During this period of recovery, data for that mote will temporarily be unavailable for data delivery, dashboards, and data feeds. See the HOBOLink help for additional details.

Sensor Alarms

To add a sensor alarm:

1. In HOBOLink, click Devices and then RX Devices, and find the station you want to configure. Click the arrow next to  and select Alarm Configuration.

2. Click Add a Sensor Alarm.
3. Set up the Sensor Condition for the alarm.
 - a. Select the sensor.
 - b. **For rain gauge sensors:** This is based on accumulated rainfall in inches or mm (depending on the units set in HOBOLink) over a period of minutes or hours (up to 24). Enter the number of minutes or hours you want the rainfall to be accumulated over, and the amount of rain in inches or mm you want to trigger the alarm.
 - c. **For all other sensors and channels:** Select whether the alarm should trip above or below a value or outside a range. Enter the sensor reading(s) for the alarm threshold. Enter the number of logged data points you want the station to record before the alarm trips.
 - d. If you selected the alarm to trip above or below a specific reading, then select when the alarm should clear: above or below the same value or a different value. Enter the value if necessary.
4. Select the action to be taken when the alarm trips: send an email or text. Enter the details and then select "Send on Clear Also" if you want an email or text when the alarm clears as well.

Important: Standard data fees and text messaging rates may apply when using text notifications. Onset does not charge a fee or guarantee delivery of text alerts, which is subject to your carrier's service and location. See the HOBOLink Help for additional details on alarm notifications.

5. Click Add Action if you want multiple actions to be taken when the alarm trips (for example, send an email and a text).
6. Add any optional notes for this alarm.
7. Click Save. Changes will take effect the next time the station connects to HOBOLink.
8. Repeat steps 2 through 7 for each additional sensor alarm you want to add.

If an alarm trips on a sensor, the station will automatically connect to HOBOLink to report the tripped alarm. A red alarm symbol appears next to that sensor in HOBOLink when it trips. An alarm symbol will also appear on the LCD.

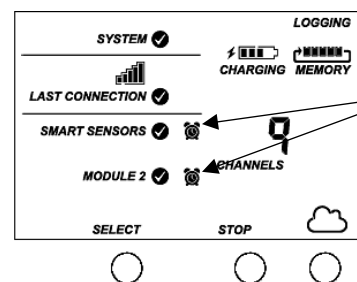

Tripped smart sensor and wireless sensor alarms

Alarms for HOBOLink calculated channels (such as dew point) are checked at the connection interval for the station. This is because calculated channels are generated from data uploaded at each connection interval.

Accumulated rain alarms are triggered by the station as soon as the alarm conditions are met. The alarm will remain tripped for one accumulation interval after the trip. For example, if you set the alarm to trip for 2 inches of rainfall accumulated in 4 hours,

then it will be 4 hours before an alarm clear message is sent after the alarm is triggered--unless enough rain has continued to accumulate that causes the alarm to trip again.

Starting and Stopping Logging

You can start and stop logging with the Start/Stop button on the station or from HOBOLink.

To start and stop logging with the station:

1. When the station is stopped, press the Start button to start logging. The device will connect to HOBOLink ("Connection" will blink on the LCD) and then logging will begin at the logging interval specified for smart sensors (if applicable) and wireless sensors.

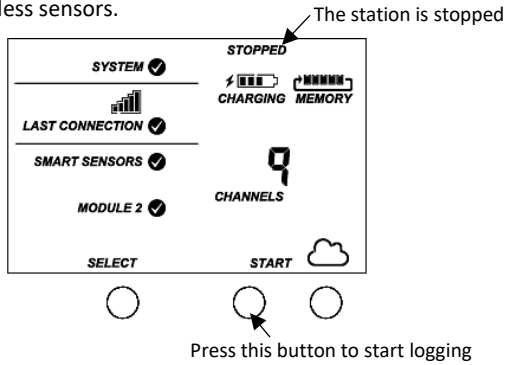

2. To stop logging, press the Stop button. Logging stops immediately. Note that the station does not immediately connect when the station is stopped, but it will continue to connect to HOBOLink at the connection interval set in HOBOLink even if it is not logging.

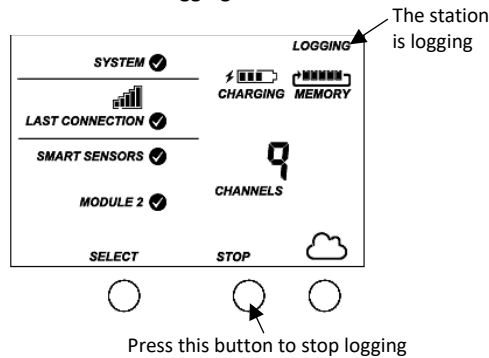

To start and stop the station from HOBOLink:

1. Click Devices and then RX Devices, and find the station you want to start or stop. Click the arrow next to and select Start/Stop.
2. Click Start or Stop. The station will start or stop logging the next time it connects to HOBOLink.

Adding or Removing Smart Sensors

To add or remove smart sensors from the station:

1. If the station is currently logging, press the Stop button to stop it.
2. Press the Connect button and wait for the station to connect to HOBOLink so that all the latest data is offloaded before changing smart sensors.
3. Unplug any smart sensors you wish to remove. Plug in any new smart sensors. Lightly coat the portion of the cable(s) that will be placed in the cable channel with a small amount

of silicone grease. Push each new sensor cable into the hole that lines up with the corresponding sensor connector. Use the integrated plugs in the cable channel to fill any empty holes.

4. Press the Select button to view the smart sensors on the LCD screen.

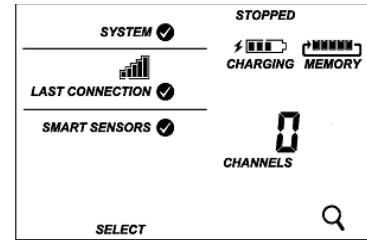

5. Press the Search button for the station to detect all the smart sensors currently connected (the magnifying glass icon should be visible as in the previous example).
6. Press the Start button to begin logging again. The station will automatically connect to HOBOLink.
7. Make sure the cable channel is securely in place and close the station door.
8. Make any configuration changes in HOBOLink as desired, such as adding sensor labels or scaling (see *Setting up the Station*).

Note that any existing alarms associated with removed sensors will still be listed in HOBOLink. See the HOBOLink Help for details on deleting alarms.

Important: If you are using smart sensors only and no wireless sensors, power down the station and unplug the manager to preserve battery power.

Adding or Removing Motes

To add a mote to the wireless sensor network:

Important: Keep the mote near the station while completing these steps.

1. If the LCD is blank on the station, press any button to wake it up.
2. Press the Select button to view module 2.

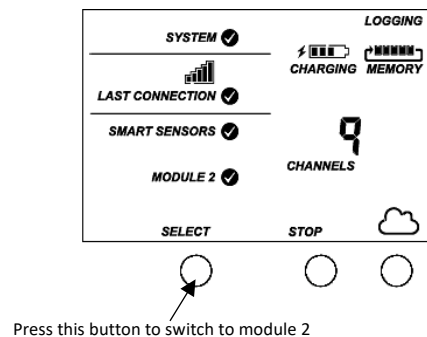

- Press the Search button (the magnifying glass). The magnifying glass icon will blink while the station is in search mode.

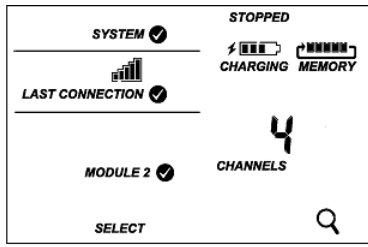

Press this button so the station is ready to have motes join the network

- Open the mote door and install the batteries if you have not already done so.
- Press the button on the mote for 3 seconds. The signal strength icon will flash and then cycle.

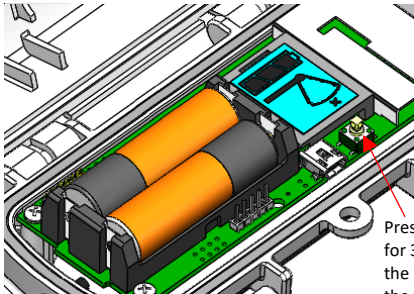

Press this button for 3 seconds for the mote to join the network

- Watch the LCD on the mote.

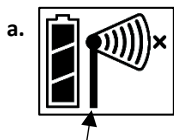

This signal strength icon blinks while searching for a network.

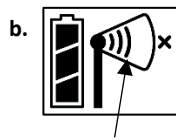

Once a network is found, the icon will stop flashing and the bars will cycle from left to right.



This network connection "x" icon blinks while the mote completes the registration process, which may take up to five minutes.



Once the mote has finished joining the network, the "x" icon is removed and the channel count on the station LCD increases by the number of measurement channels for the mote plus the battery.

The green LED blinks quickly while the mote searches for a network to join and then blinks slowly while it completes the network registration. Once the mote has finished joining the network, the green LED turns off and the blue LED then blinks indefinitely while the mote is part of the network.

Note: If the mote cannot find the network or has trouble remaining connected during this process, make sure the mote is in a vertical, upright position and within range of the station.

- Repeat steps 4–6 for any additional motes to add.
- Press the Search button (the magnifying glass) on the station to stop searching for motes.

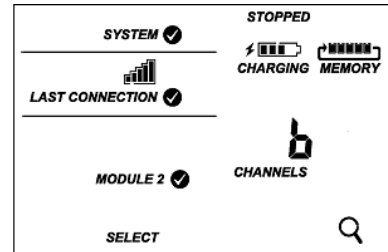

Press this button again to stop searching for motes

Measurements will be recorded at the logging interval specified in HOBOLink, transmitted to the station, and uploaded to HOBOLink at the next connection interval (readout).

To remove a mote from the network:

- In HOBOLink, click Devices, then RX Devices, and find the station with the mote you want to delete. Click the arrow next to and select Module/Sensor Configuration.
- Select the mote serial number or name from the Configuration menu as shown in the following example.

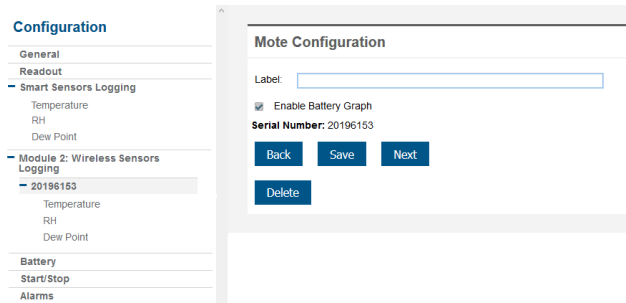

- Click Delete to remove the mote from the network.
- If the mote you are deleting is currently active on the network (i.e. powered up and transmitting data), the station will need to connect to HOBOLink to complete the removal process. Otherwise, the mote will not officially leave the network and can attempt to automatically rejoin the network in the future. To connect to HOBOLink, press the Connect button on the station. Once the station is connected, a command is sent to the station and the mote permanently leaves the network.

Important: If you remove all motes from the network and are using smart sensors only, power down the station and unplug the manager to preserve battery power.

Managing Connections to HOBOLink

The station will connect to HOBOLink on the connection interval you selected in Readout Configuration.

To change the connection schedule:

1. Click Devices and then RX Devices, and find the station you want to configure. Click the arrow next to  on the Devices page and select Readout Configuration.
2. Set the connection interval. The minimum connection interval depends on your communication plan.
3. If you wish to set up a second connection interval, select the "Night Mode" checkbox. Select when night mode should begin and end and then enter the connection interval you want to use during that part of the day.
4. Click Save. The changes to the connection interval will take place the next time the station connects to HOBOLink.

You can also connect to HOBOLink from the station at any time, regardless of the connection schedule. Press the Connect button on the station to connect to HOBOLink. Unless the station is running on a night mode connection interval, the normal connection schedule will then restart after the connection is complete. For example, a station is configured to connect hourly and the last connection on its regular schedule occurred at 10:05. If you use the Connect button on the station to connect to HOBOLink at 10:15, the next connection will then be about 11:15 based on the one-hour connection interval. Similarly, if a station misses a connection, the connection schedule will shift depending on the time of the next successful connection. While the station is using a second, night mode schedule, all connections will follow that schedule only; any extra connections while the station is in night mode will not cause a shift in the connection schedule.

Also note that the station will connect to HOBOLink when the device is powered up and when you press the Start button.

Note: All connections to HOBOLink count toward your communications plan. If the station is nearing its limit for monthly cell use, minimize unscheduled connections. This includes any connections for alarms or changes you make to the connection schedule. You can also increase the connection interval to reduce the number of connections to HOBOLink per day. Go to the Device Information section on your station page in HOBOLink to check the status of the monthly communications plan usage for the station.

Deployment Guidelines

Follow the guidelines and steps in this section for deploying and mounting the station.

Guidelines for Deploying the Station

- Check the signal strength on the LCD in the location you wish to deploy the station to make sure it will be able to reliably connect to HOBOLink. The station may have difficulty connecting if there is only one bar illuminated in the signal strength icon on the LCD. (The signal strength shown on the LCD is from the last connection.)
- The station must be mounted at least one foot from all sensors to avoid interference from the built-in radio module and antenna with the measurements made by the sensors.
- Make sure the station remains in a vertical position once it is placed in its deployment location to prevent pooling of water on the cable entries. In addition, if it is mounted horizontally, the battery could be damaged over time in

RX2106 models as it is charged and the antenna in both models will not have optimal range.

- If possible, avoid sites immediately adjacent to radio/television/microwave towers and equipment. In rare situations, strong electromagnetic interference may result in sensor network errors.
- If you are using a wind speed/direction sensor or if the station will be installed on a roof or in a location with exposure to lightning, use a grounding wire (CABLE-MICRO-G). A grounding wire may also reduce potential sensor errors that can result from installing near other radio or electrical equipment or antennas. See *Installing the Grounding Wire*. Also, ground the tripod or mast using appropriate grounding, such as the Grounding Kit (M-GKA).
- Take note of the mounting considerations in the sensor manuals at www.onsetcomp.com/support/manuals for additional guidelines for the sensors you are using.
- Make sure all cables and wires are fastened securely and routed through the cable channel. Any empty holes in the cable channels need to be filled with the integrated plugs to ensure the station is weatherproof if installed outdoors or to protect it from harsh indoor environments (see the diagrams in *Installing the Cable Channel* for how to insert the plugs).
- When using the AC adapter (P-AC-1) with the cable channel installed in the RX2105 station, route the AC adapter cable through the far-left hole in the cable channel. Tuck the cable into the left side of the hole and use the integrated cable channel plug in the same hole (see the diagrams in *Installing the Cable Channel* for how to insert the plug). The far-left hole is slightly bigger than most other holes in the cable channel and can accommodate both the AC adapter cable and the integrated plug at the same time.
- Do not store excess sensor cable wire coiled inside the station case or within one foot outside the case.
- Protect cables and wires with conduit. Exposed cables can be chewed by rodents.
- Make sure the total cable length for all installed smart sensors does not exceed 100 m (328 ft).
- Consider using a padlock to restrict access to the station. With the station door closed, hook a padlock through one of the latches on the right side of the door and lock it.
- The RX2106 station has a built-in solar panel to recharge the NiMH battery pack. Connect the solar panel cable to keep the battery charged. When mounting the station, position the solar panel in the direction where it will receive the most sunlight through the day and throughout each season. It may be necessary to periodically adjust the station position as the path of sunlight changes throughout the year or if the tree and leaf growth alters the amount of sunlight reaching the solar panel.
- If the location where you want to install the RX2106 station does not produce enough sunlight to charge the battery, use an external solar panel (SOLAR-xW). Disconnect the built-in solar panel cable and tuck it in the station door. Plug in an external solar panel. Lightly coat the portion of the cable that will be placed in the cable

channel with a small amount of silicone grease. Route the external solar panel cable through far-left hole in the cable channel.

Guidelines for Deploying HOBONet Wireless Motes

- Stay close to the station when adding motes to the wireless network because you will need to access both the station and the mote at the same time. After the mote has successfully joined the wireless network, you can then move it to its deployment location.
- Check the signal strength on the mote LCD at the location where you want to place the mote. If there is only one or two bars on the signal strength indicator, consider moving the mote to a location where the signal strength is stronger.
- Consider using a plastic pole such as PVC to mount the motes.
- When deploying motes outdoors, make sure motes are mounted a minimum of 1.8 m (6 feet) above the ground or vegetation to help maximize distance and signal strength as shown below.

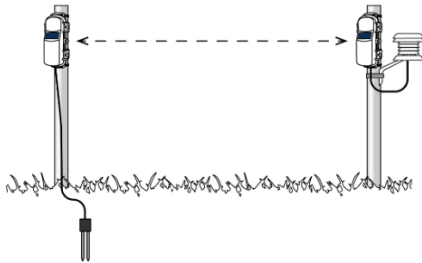

- When deploying motes outdoors, make sure each sensor mote and repeater is positioned so that the built-in solar panel receives optimal sunlight throughout each season as shown. It may be necessary to periodically adjust the mote position as the path of the sunlight changes throughout the year or if tree and leaf growth alters the amount of sunlight reaching the solar panel.

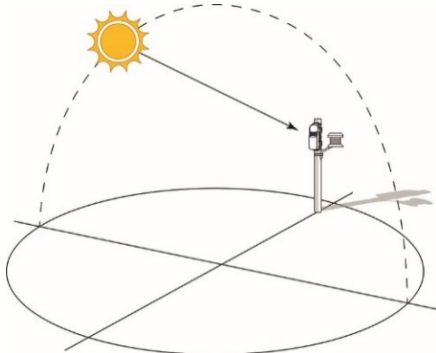

- Obstructions between motes can prevent reliable network communication. If the mote is blocked by a small obstruction (e.g. a pole, the station, shrubbery), then move the mote to a location where the obstruction is not blocking the path to the nearest mote. If there is a large obstruction in the way (e.g. a wall, building, or tree) or a change in elevation between motes, then either reposition the mote until there is full line of sight to the next mote or add a repeater between them. The following diagram

shows an example of using a repeater in an outdoor environment.

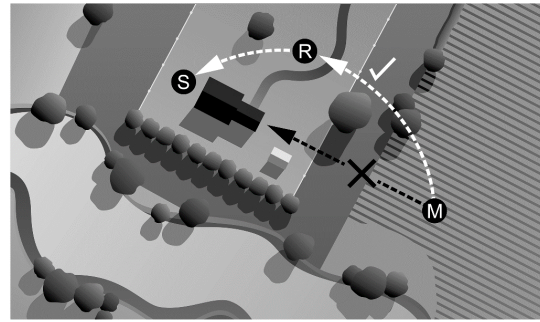

S Station R Repeater M Mote

- There should not be more than five motes in any direction at their maximum transmission range from the station. Data logged by a wireless sensor must travel or “hop” across the wireless network from one mote to the next until it ultimately reaches the station. To make sure the data can successfully travel across the network, the mote should not be more than five hops away from the station.
- The HOBONet wireless network can support up to 50 wireless sensors or 336 data channels per one HOBONet RX station.
- Use the Map feature in HOBOLink for a bird’s eye view of the network and wireless paths. See the HOBOLink Help for details on this and other ways to monitor the status of your network and sensor data.
- Use cable ties or screws to mount the mote via the holes on the mounting tabs.
- Make sure the mote remains in a vertical position once it is placed in its deployment location for optimal network communications.
- Make sure the mote door is closed, with both latches fully locked to ensure a watertight seal in outdoor environments and to protect it in indoor environments.
- Consider using a 3/16 inch padlock to restrict access to the mote. With the mote door closed, hook a padlock through the eyelet on the right side of the door and lock it.
- Mount the manager as high as possible above the station to increase the radio signal and line of sight.
- Make sure the manager cable is hanging straight down and not pulled tightly to the side to connect to the station.

Installing the Grounding Wire

If you are using a grounding wire (CABLE-MICRO-G), attach it to the grounding wire port on the back of the station. Use the screw and washer included with the grounding wire to attach it to the port.

- If you are mounting the station on a tripod or mast, use the optional U-bolts (U-BOLT-KIT2). Attach the grounding wire under one of the nuts on one end of the U-bolt.
- If you are mounting the station on a metal post, clamp the grounding wire to the metal post with a hose clamp or a U-bolt.
- If you are mounting the station to a flat surface, attach the grounding wire to a proper ground. Note that the

grounding wire may prevent the logger from being flat against the surface. Be careful not to bend the case when tightening screws.

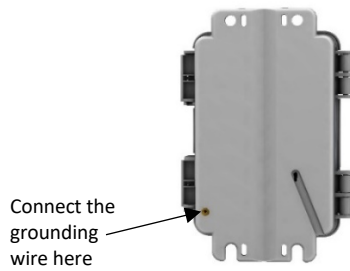

Mounting the Station

There are three ways to mount the station using the built-in mounting tabs.

- Use the two sets of outer holes and 1-5/8 inch saddle-clamp U-bolts to attach the logger to a tripod or mast (this is the recommended method for mounting on a mast). Do not use U-bolts without the saddle clamps as that could bend the mounting tabs and damage the housing or compromise the weatherproof seal in outdoor environments. The flat portion of the saddle clamps should be against the mounting tabs.
- Use the included cable ties with the two sets of inner holes to affix the logger to a PVC pipe or mast.
- Use the included screws and washers with the two sets of outer holes to adhere the logger to a wall or flat surface.

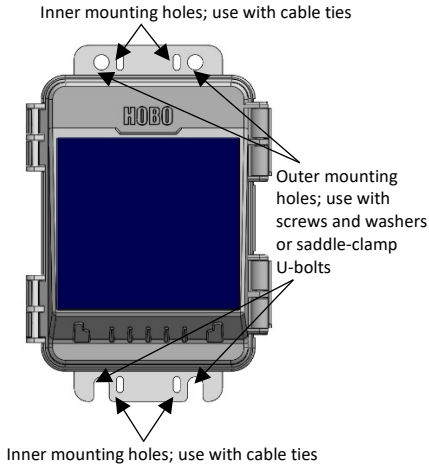

Important: See *Deployment Guidelines* and *Installing the Grounding Wire* for installation steps and other deployment guidelines.

Installing the Cable Channel

Important: This is required for outdoor and weatherproof deployments and recommended for harsh indoor environments where debris could enter the station.

1. Make sure all sensors and cables are installed, including the solar panel, AC adapter cable, or external DC power cable, and the grounding wire.

2. Use the integrated plugs to fill any unused holes. Bend the plugs up so that you can push them into the holes. Once a plug is partially pushed through, you can pull on the part of the plug that is inside the case. You may need to bend the ends of the channel slightly to widen the holes for installing the plugs.

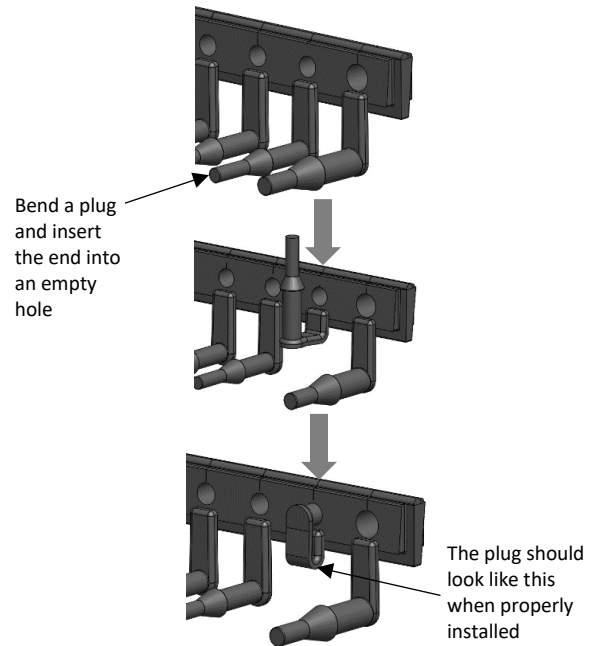

3. Lightly coat the portion of the sensor cables that will be in the cable channel with a small amount of silicone grease (about the size of a pea).
4. Lightly coat the bottom and two sides of the cable channel with silicone grease.
5. Reinstall the cable channel in the station making sure the key on the bottom is inserted in the notch in the station enclosure.

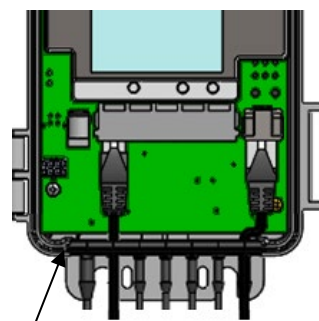
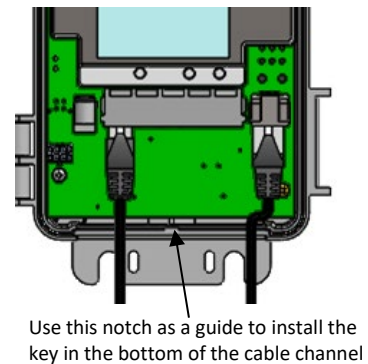

Cable channel reinstalled



Care and Maintenance

Periodically inspect the station and manager as follows:

- Verify the station enclosure is free of visible damage or cracks.
- Make sure the station is clean. Wipe any dust or grime off with a damp cloth.
- For RX2106 models, make sure the built-in solar panel is clean. Wipe off any debris with a damp cloth.
- Wipe any water off the station before opening it (if applicable).
- Check that all cables and wires are free of damage, such as cracks, cuts, and splits.
- Make sure cables and wires are still fastened securely and any conduit is still intact.
- Grease the sides and bottom of the cable channel and the portion of the cables in the cable channel with a small amount of silicone grease.
- Verify that all cables and wires are free of corrosion. If moisture is visible inside the station, open the door to air it out. Be sure to determine the source of the moisture and fix it. Check the cable channel and cover seals for any sign of moisture entry.
- Make sure the cable channel is intact and installed properly, and the latches are fully locked when the station door is closed.
- Verify the manager mote is free of visible damage or cracks. Make sure it is clean and wipe off any dust or grime with a damp cloth. Wipe off any water before opening the mote. Make sure the interior seal is intact and the latches are fully locked when the mote door is closed.

Updating Manager Firmware

If a new firmware version is available for the manager, use HOBOLink to download the file to your computer.

1. In HOBOLink, go to Devices > RX Devices and click the station name.
2. On the station page, click Overview and scroll down to Device Information.
3. Click the Wireless tab. This icon  appears next to the module if there is a new version of firmware available.
4. Click the firmware  upgrade link. Click Download and save the firmware .bin file to your computer.
5. Connect the mote to the computer with a USB cable (open the mote door and use the USB port to the right of the LCD). The blue LED is illuminated while connected.
6. The mote appears as a new storage device in the computer's file storage manager. Copy the downloaded firmware file to the new storage device (the mote). The blue LED will blink slowly while the file is copying.
7. After the file is copied to the mote, the LED will stop blinking and remain a steady blue. Eject the storage device from the computer and disconnect the cable from the mote. The firmware installation process will begin automatically on the mote. The blue LED will blink rapidly while the firmware is installed. Once the firmware

installation is complete, the LCD symbols return and the mote will automatically rejoin the network.

Notes:

- **Mac® users:** A message may appear indicating the disk has not ejected properly when disconnecting the mote from the computer. The mote is operational and you can ignore the message.
- If the blue LED turns off abruptly while copying the file or installing the firmware, a problem has occurred. Contact Onset Technical Support for help.

Troubleshooting

Error codes can appear on the LCD if a problem arises with the station or a sensor. This table describes common error codes that may appear. Contact Onset Technical Support for help.

Fault Code #	Description	Action to Take
001	System Failed Initialization	Power cycle the station (disconnect the battery and charging device, wait for a minute, and then plug the battery and charging device back in).
004	Sensor Error/Fault	Check the smart sensor data in HOBOLink to see which smart sensor is producing an error. You may need to remove or replace the smart sensor if the smart sensor is consistently reporting erroneous data.
129	Smart Sensor Bus Fault	There is a problem with one or more of the smart sensor connections. Check that all smart sensors are fully plugged in (follow the instructions in <i>Adding or Removing Smart Sensors</i>). Also check that the smart sensor cables are ok.

Battery Information for the RX2105 Model

The RX2105 station runs continuously with the included AC adapter plugged into the AC adapter port. Six user-replaceable AA 1.5 V lithium batteries can be used as a backup to AC power. Expected battery life varies based on the ambient temperature where the station is deployed, the frequency of connections to HOBOLink, the number of sensors connected, the number of motes in use, the logging or sampling intervals selected, the number of tripped alarms, and other factors.

Battery life for the RX2105 model and approximately 10 motes is 3 months with a 1-minute logging interval and daily connections to HOBOLink or 2 months with a 1-minute logging interval and hourly connections. Deployments in areas with weak cellular strength could reduce battery life. Deployments in extremely cold or hot temperatures, logging intervals faster than 1 minute, or a sampling interval faster than 15 seconds can impact battery life. Estimates are not guaranteed due to uncertainties in initial battery conditions and operating environment.

⚠ WARNING: Do not cut open, incinerate, heat above 85°C (185°F), or recharge the lithium batteries. The batteries may explode if the logger is exposed to extreme heat or conditions that could damage or destroy the battery cases. Do not mix battery types, either by chemistry or age; batteries may rupture or explode. Do not dispose of the logger or batteries in fire. Do not expose the contents of the batteries to water. Dispose of the batteries according to local regulations for lithium batteries.

To replace the batteries:

1. Open the station door.
2. Disconnect the battery cable.
3. Use a flat-head screwdriver to remove the screw below the battery cover.

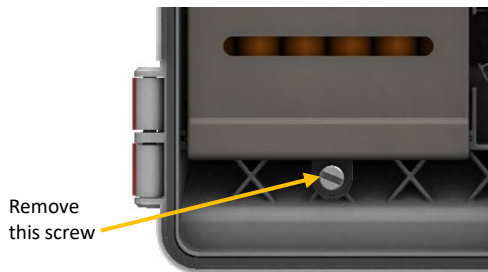

4. Pull to remove the battery cover.
5. Remove the old batteries.
6. Install six new batteries observing polarity.
7. Reinstall the battery cover.
8. Use a flat-head screwdriver to secure the cover with the screw.
9. Plug in the battery cable.

Battery Information for the RX2106 Model

The RX2106 station uses one rechargeable NiMH battery pack (HRB-NiMH-6). Typical battery life is 3–5 years when operated in the temperature range -20° to 40°C (-4° to 104°F); operation outside this range will reduce the battery service life. Use the AC adapter (P-AC-1), built-in solar panel, or external solar panel (SOLAR-xW) to keep the battery charged. If using an external solar panel or built-in solar panel, the quality and quantity of solar light can affect whether the battery is sufficiently charged to last through the night and cloudy periods.

The maximum connection rates when using the built-in solar panel in full sun are:

- 10 minute connections year round for latitudes less than ±40°
- 10 minute connections through three seasons in other regions, reduced to 30 minute connections in winter

The maximum connection rate when using an external 5W or 15W solar panel is 10 minute connections year round, in full sun. The connection rate with external solar panels may be less if deployed in partial sun.

Battery life for the RX2106 model is 1 month without solar recharging, with hourly connections, a 1-minute logging interval, and approximately 10 notes.

Deployments in extremely cold or hot temperatures, a logging interval faster than 1 minute, or a sampling interval faster than 15 seconds can impact battery life. Estimates are not guaranteed due to uncertainties in initial battery conditions and operating environment. If using an external solar panel or built-in solar panel, the quality and quantity of solar light can affect whether the battery is sufficiently charged to last through the night and cloudy periods.

The station will shut down once the battery voltage drops to 6 V. Plug in an AC adapter or solar panel to recharge it. Once the voltage rises to 7.5 V, the station will power up. If the charging device is not recharging a dead battery, contact Onset Technical Support.

To replace the battery pack:

1. Open the station door.
2. Disconnect the battery cable.
3. Use a flat-head screwdriver to remove the screw below the battery cover.

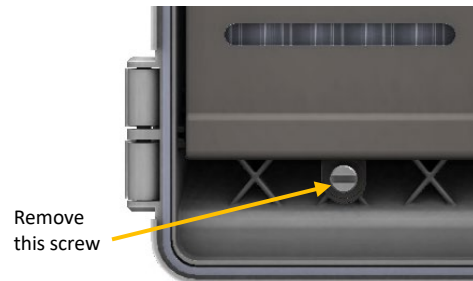

4. Pull to remove the battery cover.
5. Remove the old battery pack and install the new one from Onset.
6. Reinstall the battery cover.
7. Use a flat-head screwdriver to secure the cover with the screw.
8. Plug in the battery cable.
9. Make sure the built-in solar panel cable is plugged in. If you are using an external solar panel, make sure the built-in solar panel cable is tucked inside the station door. Plug in the external solar panel. Lightly coat the portion of the cable that will be placed in the cable channel with a small amount of silicone grease. Route the cable through the far-left hole in the cable channel.

⚠ WARNING: Dispose of the battery pack according to local regulations for NiMH batteries.

**WARNING**

This station contains a radio and is not approved for use on airplanes. Disconnect the battery and all power sources before flight.

Federal Communication Commission Interference Statement

This equipment has been tested and found to comply with the limits for a Class B digital device, pursuant to Part 15 of the FCC Rules. These limits are designed to provide reasonable protection against harmful interference in a residential installation. This equipment generates uses and can radiate radio frequency energy and, if not installed and used in accordance with the instructions, may cause harmful interference to radio communications. However, there is no guarantee that interference will not occur in a particular installation. If this equipment does cause harmful interference to radio or television reception, which can be determined by turning the equipment off and on, the user is encouraged to try to correct the interference by one of the following measures:

- Reorient or relocate the receiving antenna
- Increase the separation between the equipment and receiver
- Connect the equipment into an outlet on a circuit different from that to which the receiver is connected
- Consult the dealer or an experienced radio/TV technician for help

This device complies with Part 15 of the FCC Rules. Operation is subject to the following two conditions: (1) This device may not cause harmful interference, and (2) this device must accept any interference received, including interference that may cause undesired operation.

FCC Caution: Any changes or modifications not expressly approved by the party responsible for compliance could void the user's authority to operate this equipment.

Industry Canada Statements

This device complies with Industry Canada license-exempt RSS standard(s). Operation is subject to the following two conditions: (1) this device may not cause interference, and (2) this device must accept any interference, including interference that may cause undesired operation of the device.

Avis de conformité pour l'Industrie Canada

Le présent appareil est conforme aux CNR d'Industrie Canada applicables aux appareils radio exempts de licence. L'exploitation est autorisée aux deux conditions suivantes : (1) l'appareil ne doit pas produire de brouillage, et (2) l'appareil doit accepter tout brouillage radioélectrique subi, même si le brouillage est susceptible d'en compromettre le fonctionnement.

To comply with FCC and Industry Canada RF radiation exposure limits for general population, the logger must be installed to provide a separation distance of at least 20cm from all persons and must not be co-located or operating in conjunction with any other antenna or transmitter.

NCC Statement

經型式認證合格之低功率射頻電機，非經許可，公司、商號或使用者均不得擅自變更頻率、加大功率或變更原設計之特性及功能。

低功率射頻電機之使用不得影響飛航安全及干擾合法通信；經發現有干擾現象時，應立即停用，並改善至無干擾時方得繼續使用。前項合法通信，指依電信法規定作業之無線電通信。低功率射頻電機須忍受合法通信或工業、科學及醫療用電波輻射性電機設備之干擾。

Translation:**Article 12**

Without permission granted by the NCC, any company, enterprise, or user is not allowed to change frequency, enhance transmitting power or alter original characteristic as well as performance to an approved low power radio-frequency device.

Article 14

The low power radio-frequency devices shall not influence aircraft security and interfere with legal communications. If found, the user shall cease operating immediately until no interference is achieved. The said legal communications means radio communications is operated in compliance with the Telecommunications Act. The low power radio-frequency devices must be susceptible with the interference from legal communications or ISM radio wave radiated devices.